

Diagnostic X-Ray Equipment

Operation manual

Technical manual



User Registration

On the inscription plate at the back of the instrument, you will find the unit's model number, serial and reference number. Please double check the numbers and fill in the form with them, and quote the reference number, when you are in contact with your distributors.

Product Name:

Product Model:

Serial Number:

Date of Manufacturer:

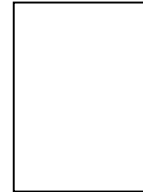

Software Released Version: The software version is displayed on the boot screen, starting with P, such as P01.

* Before operating, please read carefully all safety cautions and instructions for operation. This user manual will help you understand all functions of Runyes Portable x ray instrument as much as possible.

* Please read carefully the instruction of this user manual while servicing and maintaining the units.

* Please keep this user manual for your future reference.

* If error occurs during operation of the instrument, please contact engineer.

* Product expected service life: 8 years.

Table Contents

- 1.Overview**
- 2.Technical data**
- 3.Check List - Before Using the Equipment**
- 4.Product Composition**
- 5.Operation**
- 6.Error Instructions and Codes**
- 7.Safety**
- 8.Cleaning and disinfection**
- 9.Maintenance and inspection**
- 10.X ray Tube Characteriscs**
- 11.Assembly, Dimension and Drawing**
- 12.Accessories list**
- 13.Waste disposal Process**
- 14.Electro Magnetic Compatibility**

1. Overview

1.1 Intended use

Diagnostic X-ray Equipment is intended to use for medical units for dental X-Ray radiology diagnostic.

Contraindications: Use with caution in pregnancy cases.

1.2 Composition

Diagnostic X-ray Equipment is mainly composed of X-Ray tube head, control system, battery, adaptor, beam limiting device and handheld exposure device.

1.3 Classification

Type of protection against electric shock: The adaptor is CLASS I ME EQUIPMENT, The host machineis INTERNALLY POWERED ME EQUIPMENT.

Degree of protection against electric shock: TYPE B APPLIED PART

Applied part: Beam limiting device.

Not belong to the category AP or APG device.

Degree of protection against harmful ingress of water: IPX0.

Disinfection method: See Chapter 8.

1.4 User's responsibility

The user must:

- * Use this equipment in accordance with the relevant operation and maintenance instructions in this manual.
- * The manufacturer and its distributors assume no responsibility for personal injury or property damage, equipment damage, or malfunctions caused by improper use or maintenance of the user.
- * In the event of an accident related to this equipment or a change in function or performance that could cause death of a patient or operator, personal injury or health hazard, the health authorities and the manufacturer or their agents should be notified immediately.
- * The product model and factory number should be included in the problem feedback report provided by the user to the manufacturer, and the user can obtain this information from the technical label.

1.5 Warnings and precautions

⚠ The use and operation position of public equipment is very important. The radiation safety requirements of each country and region are different, and the equipment should be shielded. It is the responsibility of the user to ensure compliance with local safety requirements.

⚠ Runyes Diagnostic X-ray Equipment may produce ionizing radiation, which can be hazardous to health if not properly controlled. Therefore, it is recommended that the machine be operated only by trained personnel in accordance with existing laws and regulations.

⚠ Although this equipment complies with the electromagnetic compatibility specifications, we also recommend not to use this equipment in the place where there is external electromagnetic interference. Such as high-power equipment or motor equipment etc., which can interfere with the electronic circuits of this system. Please refer to the attached Chapter 14 for EMC.

⚠ The Operator should not use the system and should inform the Customer service, if the ESSENTIAL PERFORMANCE is lost or degraded due to EM DISTURBANCES.

⚠ Turn off the power of the equipment when performing maintenance and other operations.

⚠ Public users are not allowed to open the casing of the equipment without permission. If the equipment fails, please contact the manufacturer or qualified service personnel to avoid the danger of high voltage electric shock. Do not repair this equipment without authorization of manufacturer.

⚠ Do not modify this equipment without authorization of the manufacturer.

⚠ Designed replaceable parts, such as batteries, adaptors, handheld exposure devices and other parts must use original accessories and be replaced by the distributor service personnel authorized by Runyes..

⚠ Runyes will provide circuit diagrams, component part lists, and calibration instructions that will assist distributor service personnel authorized by Runyes to repair those parts of the equipment that are designated by the Runyes as repairable by distributor service personnel, not to other personnel.

⚠ The service personnel of the equipment must be trained and written authorized by manufacturer or our authorized distributors.











⚠ Portable and mobile RF communication equipment may affect the performance of Diagnostic X-ray Equipment, and avoid strong electromagnetic interference when using, such as near mobile phone, microwave oven, etc.

⚠ Warning: To avoid risk of electric shock, this equipment must only be connected to a supply mains with protective earth when charging.

⚠ WARNING: Use of this equipment adjacent to or stacked with other equipment should be avoided because it could result in improper operation. If such use is necessary, this equipment and the other equipment should be observed to verify that they are operating normally.

⚠ WARNING: Portable RF communications equipment (including peripherals such as antenna cables and external antennas) should be used no closer than 30 cm (12 inches) to any part of the RAY98(P), including cables specified by the manufacturer. Otherwise, degradation of the performance of this equipment could result.

1.6 lable instruction

No.	Icon	Description	No.	Icon	Description
1		TYPE B APPLIED PART	6		Fragile, handle with care
2		Follow instructions for use	7		Keep dry
3		x-ray focus position	8		Date of manufacture
4		Standby	9		Serial number
5		Warning: ionizing radiation	10		Exposure Button

1.7 Conforming standard

X-RAY EQUIPMENT for DENTAL INTRA-ORAL RADIOGRAPHY ++)IEC 60601-1:2005+A1:2012

X-RAY EQUIPMENT for DENTAL INTRA-ORAL RADIOGRAPHY ++)IEC 60601-2-65:2012

X-RAY EQUIPMENT for DENTAL INTRA-ORAL RADIOGRAPHY ++)IEC 60601-1-3:2008/AMD1:2013

2. Technical data

2.1 Technical specification

Charger input:100 - 240V~ Frequency:50/60Hz Output:19V === 3.43A

Internal battery pack: model 18650*3S, 10.8V === , 2500mAh

Host input voltage: 19V ===

Power resistance: $\leq 2\Omega$

Ray type: X ray

Ray direction and distribution: diameter of beam limiting device exit direction 60mm

Dose rate:2mGy/s

X ray tube model:KL11

Target material: Tungsten

Target angle:12.5°

FOCUS:0.4mm

Tube voltage:70kV \pm 10%

Tube current:2mA \pm 20%

Loading time adjustment range:0.04s-2.0s deviation \pm (10%+1ms), Adjusting way please press R*10 Coefficient choice.

Nominal electric power:0.14kW(70kV, 2mA, 0.1s)

Combination of loading factors that cause maximum output electric power:70kV, 2mA

Inherent filtration:1.0mmAL/70kV

Additional filtration:0.5mmAL/70kV

Total filtration:1.5mmAL/70kV

Half-value layer:70kV, ≥ 1.6 mmAl

Radiation leakage rate: 1 meter position \leq 0.25mGy/h (70kV, 2mA, 1s, loading interval 1s/30s)

Total weight: 1.9kg

Pipe assembly weight: 1.1kg

2.2 Beam limiting device

Focus-skin distance:20.5cm \pm 0.5cm

Output radiation field: round, ϕ 6cm \pm 0.5cm

2.3 Controlling system

Microprocessor control

Children(small); Adult(big),Teeth type options

Handheld switch with 3m spring cable.

Handheld switch can be installed from distance.

2.4 Working environment requirement

Working temperature:10°C-40°C

Relative humidity:30%RH~75%RH

Atmospheric pressure:700hPa~1060hPa

2.5 Transportation and stock conditions

Stock temperature:-20°C-55°C

Transportation temperature:-20°C-55°C

Relative humidity:10%RH ~ 85%RH

Atmospheric pressure:700hPa~1060hPa

Caution: Diagnostic X-ray Equipment need to be stocked in the indoor environment without corrosive gas and with good ventilation.

3. Check List--Before Using The Equipment

Please read the user manual carefully before using, and make sure familiar with radiation protection measures.

Make sure the films meet the working requirement and ready to be used.

Make sure the films match with develop liquid.

Make sure validity of develop liquid, and put it under proper processing temperature and concentration.

Make sure validity of films, and don't use the expired films.

If use other imaging items, please make sure the imaging items are in normal available status.

Make sure the equipment is fully charged.

4. Product Composition

4.1 Product Diagram

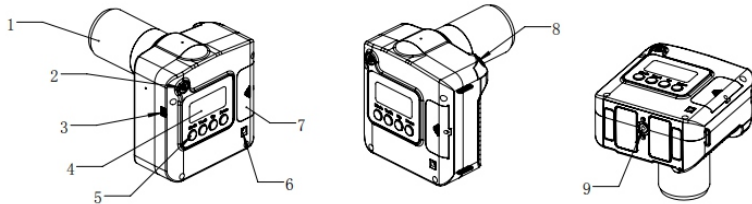

- 1. Beam limiting device 2. Standby button 3. Handheld Exposure device interface
- 4. Display 5. Function keys button 6. Battery house
- 7. Power input interface 8. Exposure button 9. Column

4.2 Host machine and handheld exposure device



One end of the handheld exposure device wire is connected to the device interface 3, and the other end is connected to the handheld exposure device.

⚠ Caution: handheld exposure device cannot be connected to other devices!

5. Operation





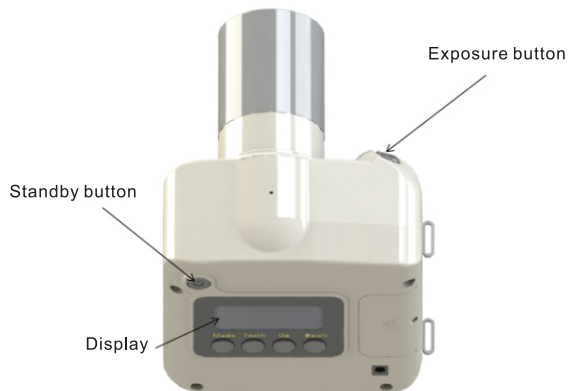



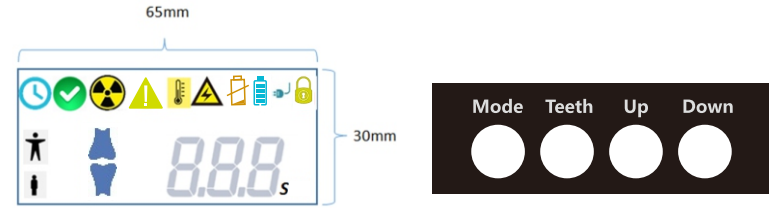











5.1 Operation process

- a. Turn on: The Standby button is located on the top of the host machine. Press the Standby button for 1s, and the LCD display will glow, notifying with beep sound.
- b. Check: Check for the sufficient battery level to ensure that the equipment is working properly.
- c. Mode Selection: Adult/children & then tooth selection.
- d. Exposure time: The system has a default time setting, users can also adjust the shooting time as needed.
- e. Imaging: Choose film or sensor imaging for the patient's teeth in the required area, press the exposure button, emit rays and have a notify sound.
- f. Cooling: After the exposure, the equipment enters the cooling countdown, standby, ready to expose again.
- g. Turn off: Press the Standby button  for 2s, it shut down with double beep sound.



5.2 Display interface symbols and its meaning



Symbols	Details	Symbols	Details
	Standby and ready for standby		Low power
	Ready		Battery power display
	Under exposure (Warning: ionizing radiation)		Charging
	Warning symbol		Lock
	High temperature warning		Adult mode
	High pressure warning		Children mode
	Upper teeth foretooth		lower tooth foretooth
	Upper molar tooth		Lower molar tooth
	Upper posterior tooth		Lower posterior tooth
	Bitewing		Bitewing
	Exposure time	Mode	Adult/child choice
Up	Increase exposure setup time	Teeth	Tooth selection
Down	Decrease exposure setting time		

5.3 Patient position

Let the patient sit on the seat and maintain the correct sitting position. The user places the film or digital imaging sensor, adjust the angle and position between the X-ray generator and the patient.

a/Parallel line technology

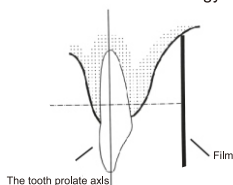

The film or digital sensor is placed in the mouth or on a film holder. The film or sensor is parallel to the long axis of the tooth.

Diagonal technology

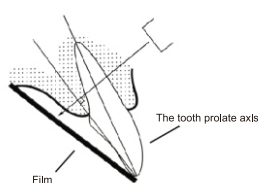

Ask the patient to hold the film or digital sensor with their fingers on the exposure position in the mouth. Position the X-ray perpendicular to an imaginary line that bisects the angle between the film or digital sensor plane and the long axis of the tooth perpendicularly.

c/X-ray inclination average angle when shooting upper and lower teeth

Tooth	X-ray tilt direction	X-ray tube tilt angle
Maxillary incisor	Tilt to the foot	+42°
Maxillary uni-cuspid	Tilt to the foot	+45°
Maxillary bicuspid and first molars	Tilt to the foot	+30°
Maxillary second and third molars	Tilt to the foot	+28°
Mandibular incisor	Tilt to the head	-15°
Mandibular uni-cuspid	Tilt to the head	-18°~-20°
Mandibular bicuspid and first molars	Tilt to the head	-10°
Mandibular second and third molars	Tilt to the head	-5°

5.4 exposure

There are two exposure methods for the user:



1. Press the exposure button on the device first, wait for the 60-second countdown on the display, and enter the exposure-ready state. Long press the exposure key again to expose.



2. After entering the ready-to-exposure state, press the exposure button on the hand-held switch again. The yellow indicator light on the handheld exposure device will light up during exposure, and the ionizing radiation symbol on the screen will light up, and there will be a beep.

Attention:

1. If it is the first use of the new machine, please adjust the exposure time to the value of 0.1s for the exposure test, when the machine is properly exposed, select another value to expose.
2. During exposure, press and hold the exposure button until the exposure is over before releasing the exposure button.

5.5 Charging and battery maintenance

Warning: adaptor's coupler or mains plug is intended to be used as the isolation means from supply mains, not to position the adaptor so that it is difficult to operate the disconnection device

The adaptor is part of the machine and is provided with the machine.

5.5.1 Charging

- a. Connect one end of the adaptor to the device's charging port and the other end to the network power (100-240V~50 /60Hz).
- b. The charging icon  appears on the screen when the device is turned on.
- c. When the battery level is full, means charging complete.
- d. Disconnect the power supply, disconnect the adaptor, once the charging completed.
- e. Full Charge: about 4 hours.

Caution: The device is only battery-powered and does not work when recharged.

5.5.2 Battery Maintenance

- a. When the machine is not in use, the Standby button should be turned off to save power.
- b. Please use the original adaptor to charge.
- c. When the battery is not used for a long time, the battery should be charged once in a three months.
- d. Avoid high and long-term single charge for more than 12 hours.

5.6 Lock device exposure

In order to prevent misoperation, this device has a lock function.

Lock: when the Mode key is pressed and the Teeth key is pressed, the upper right side of the display screen will be displayed , indicating that the device's exposure function is locked. At this time, other functions operate, the device cannot be exposed by pressing the exposure key.

Unlock: when you press the Mode key and the Teeth key again, the ICON  on the upper right of the display close, indicating that the lock is released and the device can be exposed normally.

5.7 View the cumulative dose

The device has the function of cumulative exposure dose.

When the Mode key is pressed, and then pressed the UP key, the screen shows the cumulative dose of the device that has been exposed, and the unit is uGy or mGy or kGy.

When the Mode and UP keys are pressed again to exit the dose to see the status.





5.8 Exposure time setting

When the default exposure time of the device does not meet the user's current imaging needs, the user can set the individual tooth position time.

Setting method: select the tooth position that needs to be set, adjust the exposure time through the UP key or DOWN key, after adjusting the required exposure time, press and hold the UP key and the DOWN key for 3 seconds at the same time, the system will emit two beeps indicating that the current Exposure time has been saved.

Restore the default exposure time of the device: If the user wants to restore the exposure time to the factory state of the device, he can press and hold the UP key and the DOWN key for 10 seconds at the same time, the device will emit a long beep, and the system will restore the factory default exposure time.

6. Error Instructions and Codes

Error indication	Error info	Solution
	Device exception	Re-expose or view the exposure code
	High temperature warning	Need to be cooled for 0.5-1 hours
	High voltage warning	Restart, if the fault persists, please contact the manufacturer
	Low battery	Please charge on time

Error indication	Error info	Solution
E01	Exposure terminated	Press and hold the exposure button until the exposure finish
E02	Retain	
E03	High voltage warning	Restarting the device to expose, If still fails, please contact the dealer
E04	The voltage of the X-ray tube is too high	Restarting the device to expose, If still fails, please contact the dealer
E05	The current of the X-ray tube is too low	Restarting the device to expose, If still fails, please contact the dealer
E06	The voltage of the X-ray tube is too low	Restarting the device to expose, If still fails, please contact the dealer
E07	Anode current feedback failure	Check the connection between the control panel and the ball tube or contact the dealer
E08	Anode voltage feedback failure	Check the connection between the control panel and the ball tube or contact the dealer

Attention: when an error code appears, press the UP and DOWN keys for 3 seconds to close the error code.

7. Security Features

- Only trained and authorized technicians are allowed to open the case and touch the circuit board.
- The equipment must be switched off before cleaning or disinfecting the equipment.
- Water and other liquids must not penetrate the interior of the device, as they may cause short circuits or corrosion.
- This equipment cannot be used in a flammable gas or steam environment.
- Only trained and qualified personnel should be allowed to operate this equipment and must comply with existing regulations regarding radiation protection.
- Patients should wear protective equipment when taking X-ray films. The operator and other personnel shall be at least 2 meters away from the source components of dental X-ray machine.
- Make sure that this equipment is qualified.
- The equipment contains components that must be disposed of in accordance with existing regulations.
- Do not position the Diagnostic X-ray Equipment so that it is difficult to operate the disconnection device.
- The operator shall wear a personal dosimeter and comply with local regulations.

8. Cleaning and disinfection

8.1 Cleaning

Power off the equipment before cleaning.

Users can use cotton cloth dipped in soapy water to wipe the device shell and X-Ray tube head for cleaning. Do not allow liquids to enter the device.

After cleaning, the cleaning agent should be removed. Do not let the cleaning agent remain on the surface, and use a clean, dry soft cloth to dry.

Do not use abrasive materials for cleaning.

8.2 Disinfection

It is recommended that the user uses 75% alcohol disinfection wipes, or 70% ~ 80% (volume ratio) ethanol disinfectant to soak a clean dry gauze, wipe the surface to be disinfected twice, for 3min. Air dry or wipe off the residual disinfectant with a clean, dry soft cloth.

Attention: It is recommended to disinfect once a day.

Cleaning should be done before disinfection.

Ethanol is flammable and there should be no open flame during use.

Those who are allergic to alcohol should use ethanol disinfectant with caution.

After disinfection, the residual disinfectant should be removed in time to avoid direct contact with the patient.

9. Maintenance and inspection

Do not service or maintain the Diagnostic X-ray Equipment while in use with a patient.

9.1 Daily maintenance

- a. Make sure that the device is placed where only the operator can get it.
- b. Please reserve a clean cloth to regularly clean the device.

9.2 Inspection

a. Daily inspection

- Check if the screen can be displayed normally when starting.
- Check if the keys can be used normally.
- Check if the buzzer sound works OK.
- Check if the exposure button and indicator are normal.

b. Yearly Check

The essential performance of the equipment is tested once a year by the local third-party organization. See table 201.101 in EN 60601-2-65 for the basic performance, 203.6.4.3.102 and 203.6.3.2 in EN 60601-2-65 for the test method.

9.3 Battery removal and replacement

Battery removal and replacement must be performed by the distributor service personnel. The steps are as follows:



Step 1: Screw out the screws on the battery house cover with a cross screwdriver.



Step 2: Remove the battery house cover to the right.



Step 3: Open the battery house cover.



Step 4: Take out the battery.



Step 5: Remove the battery.



Step 6: Install the new battery.



Step 7: The connector is first put into the groove at the bottom of the battery house.



Step 8: Put the battery in the bottom of the battery house.



Step 9: Push the battery house into the battery house.



Step 10: Close the battery house cover and screw in the screws.

10. X ray tube characteristics

- Filament voltage: 3.0-3.7V
- Maximum filament current: 3.0A
- Filament frequency: DC or AC (0-20kHz)
- Anode nominal input power: 585W (1s)
- Anode calorific capacity: 4300J
- Anode maximum heat dissipation: 100W
- Dimensions and wiring: As shown in figure 10-1.
- Thermal properties: Curve as shown in figure 10-2.
- Filament characteristic: Curve as shown in figure 10-3.
- Emission characteristics: Curve as shown in figure 10-3.
- Maximum rating: As shown in figure 10-4.

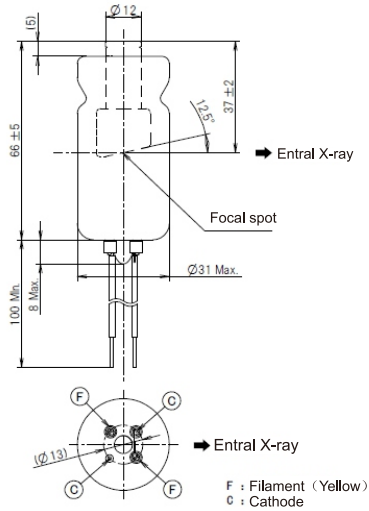

10-1 Dimensions and wiring

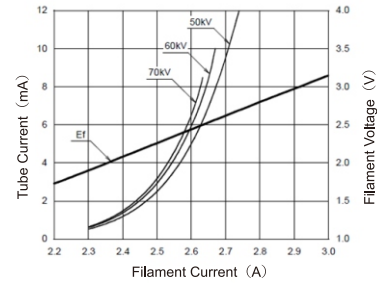

10-2 X ray tube anode heating and cooling curve

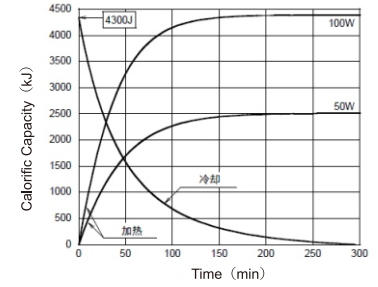

10-3 X ray tube anode heating and cooling curve

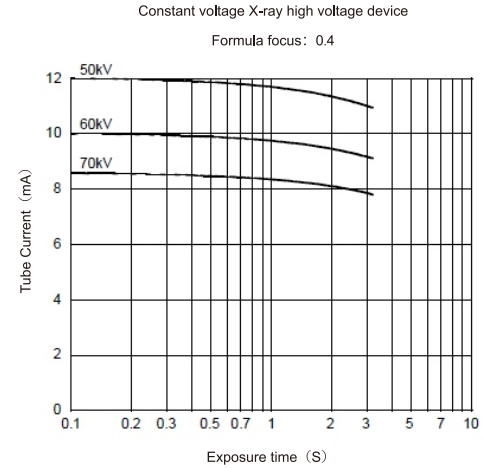

10-4 Maximum Rating

11. Assembly, Dimension and Drawing

11.1 Pipe assembly reference shaft, size, high pressure polarity

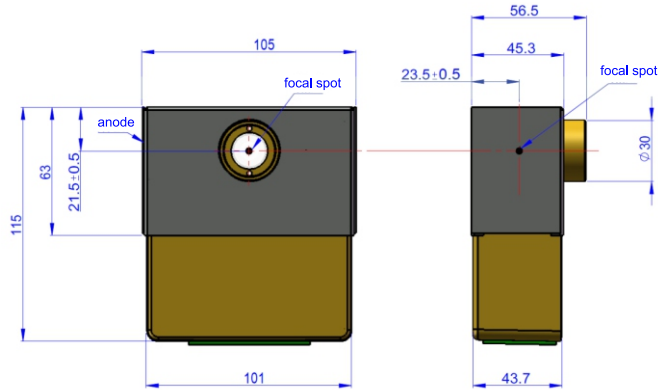

11.2 Pipe assembly wiring

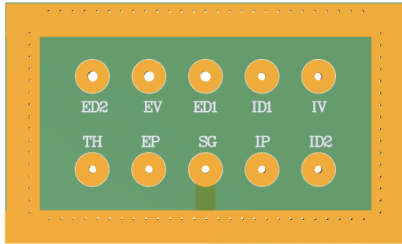

- ED1 High voltage transformer terminal 1
- ED2 High voltage transformer terminal 2
- EV power supply
- ID1 Filament transformer terminal 1
- ID2 Filament transformer terminal 2

- IV Filament transformer power supply
- SG GND
- EP High voltage feedback
- IP Current Feedback
- TH Temperature protector terminal

11.3 device dimensional drawing

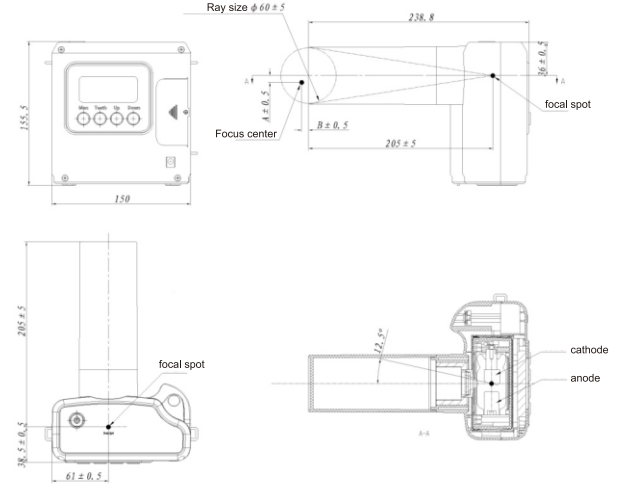

12. Accessories list

No.	Description	QTY	Remark
1	Adaptor	1	
2	Power line	1	Line length:2m
3	beam limiting device	1	
4	handheld exposure device (Optional)	1	Line length:3m /unshielded

WARNING: Use of accessories, transducers and cables other than those specified or provided by the manufacturer of this equipment could result in increased electromagnetic emissions or decreased electromagnetic immunity of this equipment and result in improper operation.

13. Waste disposal Process

In order to reduce the burden on the environment, please dispose of it according to the local laws and regulations and environmental provisions or contact the local distributor for disposal.

When disposing of waste products, necessary precautions must be taken to protect against damage.

14. Electro Magnetic Compatibility

This device complies with the relevant requirements of IEC60601-1-2: 2014 standard for electromagnetic compatibility which shown as below:

Emission and Immunity test		Basic Standard	Compliant Level/Note
Electromagnetic compatible emission	Radiated Emission	CISPR 11	Group 1, Class B
	Conducted Emission	CISPR 11	Group 1, Class B
	Harmonic Current	IEC61000-3-2	Class A
	Voltage Fluctuations and Flickers	IEC61000-3-3	Clause 5 of IEC 61000-3-3
Electromagnetic compatible immunity	Electrostatic Discharge	IEC 61000-4-2	Contact: ±8KV Air: ±2KV ±4KV ±8KV ±15KV
	Radiated RF Electromagnetic Fields	IEC 61000-4-3	10 V/m 80 MHz to 2.7 GHz 1KHz 80%AM
	Electrical Fast Transients and Bursts	IEC 61000-4-4	power port: ±2KV
	Surges	IEC 61000-4-5	line-to-line:±0.5KV ±1KV Line-to-ground:±0.5KV ±1KV ±2 KV
	Conducted Disturbance, Induced by RF Fields	IEC 61000-4-6	3Vrms 150 kHz to 80 MHz 6 Vrms ISM frequency band and radio bands
	Power Frequency Magnetic Field	IEC 61000-4-8	30A/m 50Hz/60Hz
	Voltage Dips, Short Interruptions and Voltage Variations	IEC 61000-4-11	0% UT, 0.5T at 0°, 45°, 90°, 135°, 180°, 225°, 270° and 315°; 0% UT, 1T at 0°; 70% UT, 25T at 0°; 0% UT, 250T

Test Frequency	Band (MHZ)	Modulation	LMMUNITY TEST LEVEL
(Mhz)			(V/m)
385	380-390	Pulse Modulation 18Hz	27
450	430-470	FM ±5kHz deviation 1kHz sine	28
710	704-787	Pulse Modulation 217Hz	9
745			
780			
810	800-960	Pulse Modulation 18Hz	28
870			
930			
1720	1700-1990	Pulse Modulation 217Hz	28
1845			
1970			
2450	2400-2570	Pulse Modulation 217Hz	28
5240	5100-5800	Pulse Modulation 217Hz	9
5500			
5785			

